

900W
 CHASSIS MOUNTING NON-INDUCTIVE
 HIGH POWER RESISTORS,
 WATER COOLING

RPK900L

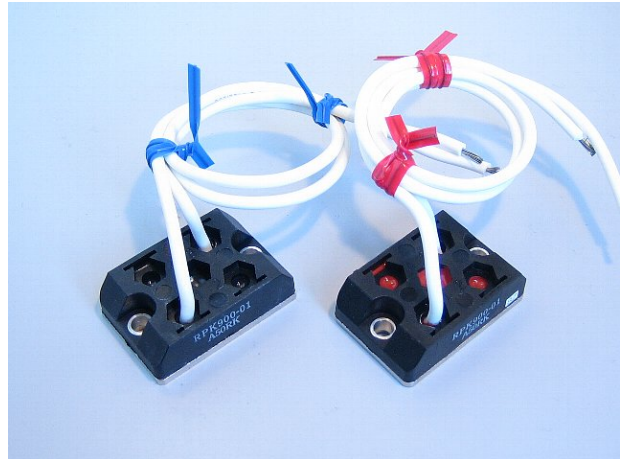

Features and Applications

Small size SOT227, 900W high power resistor. Attaching with a large forced air-cooled heat sink or liquid-cooling would be necessary for high power operation.

Rated power is 900W with 10kV - 50Hz insulation voltage and 7kV - 50kHz corona discharge.

M4 screw terminals, very low series inductance and capacitance.

Higher density packing, vibration-proof and perfect heat dissipation are available.

Applications include charge / discharge resistors, voltage divider of the high voltage pulse source for X-ray CT, MRI, EUV Laser and etc.

Dimensions and Materials

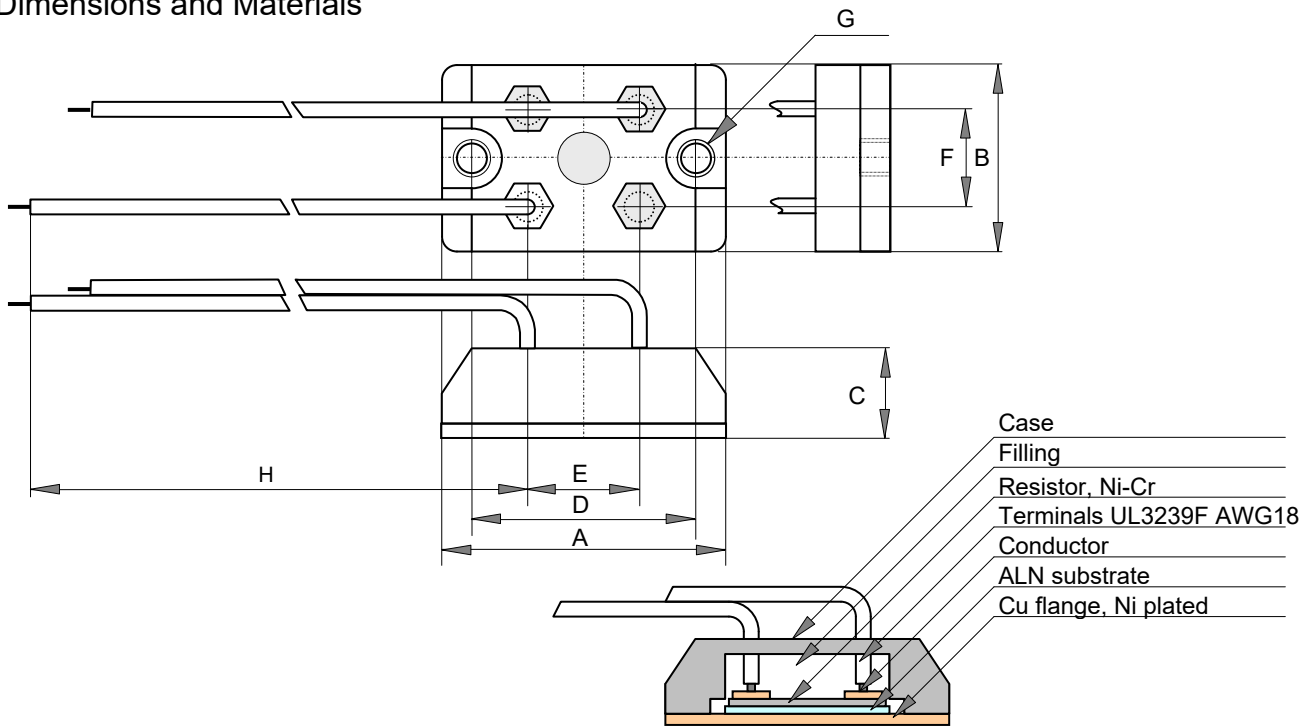

	(mm)	(inch)
A	38+/-0.5	1.50+/-0.02
B	25+/-0.5	0.98+/-0.02
C	12+/-0.5	0.47+/-0.02
D	30+/-0.2	1.18+/-0.008
E	15+/-0.5	0.59+/-0.02
F	13+/-0.5	0.51+/-0.02
G	2 - 4.20+/-0.1 dia.	2 - 0.165+/-0.004 dia.
H	250+/-10	9.8+/-0.4

900W

CHASSIS MOUNTING NON-INDUCTIVE HIGH POWER RESISTORS

RPK900L

Ordering Information

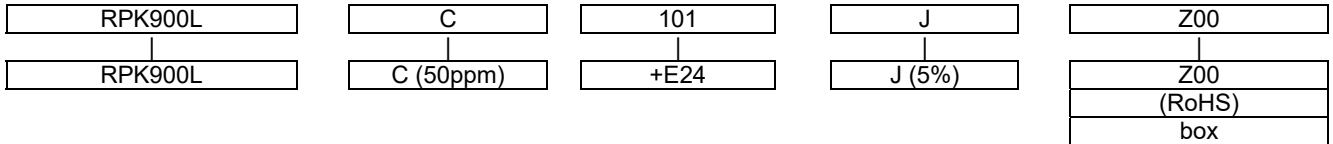

Resistance value is available following modified E24, +E24. Another is available optionally.

1.0	1.1	1.2	1.3	1.5	1.6	1.8	2.0	2.2	2.4	2.5	2.7	3.0	3.3
3.6	3.9	4.0	4.3	4.7	5.0	5.1	5.6	6.2	6.8	7.5	8.0	8.2	9.1

Specifications and Performances

Specification Items	RPK900L	Conditions
Rating Power	900 Watts	At flange temperature -55 to +25 °C
Thermal Resistance	0.10 °C/W	Between resistor to flange
Resistance Range	25 ohm to 1K ohm Single	
Nominal Resistance	Modified E24	Any value, option
TCR	+/- 50 ppm/°C (C)	For -55 to +155 °C
Tolerance	+/-5% (J)	available +/- 1% (F) option
Operation Temp. Range	-55 - +155 °C	
Limiting Voltage	Either less than 1000V or $E = \sqrt{P \cdot R}$	
Withstanding Voltage	10,000 VAC	60 seconds - 0.5mA - 50Hz
Partial discharge	7,000 V - 50kHz	Starting voltage, typical
Capacitance	13.1 pF	Parallel capacitance at 10MHz, short wire leads
Inductance	13.7 nH	Series inductance at 10MHz, short wire leads
Load Life	+/- (1.0 % + 0.05 ohm)	25°C, 90min.ON, 30min.OFF, 1000hours.
Humidity	+/- (1.0 % + 0.05 ohm)	70°C, 90 to 95%RH, DC0.1W, 1000hours.
Temperature Cycle	+/- (1.0 % + 0.05 ohm)	-55°C, 30 min., +125°C 30min., 20cycles. (-55°C, 30 min., +120°C, 30min., 5 cycles.)
Short Time Overload	+/- (5.0 % + 0.05 ohm)	Rating watt×1.5, 5seconds, with heat sink.
Insulation Resistance	Over 1000 meg ohm	Between terminals and flange.
Vibration	+/- (0.25 % + 0.05 ohm)	
Weight	38 grams	Without wire terminals

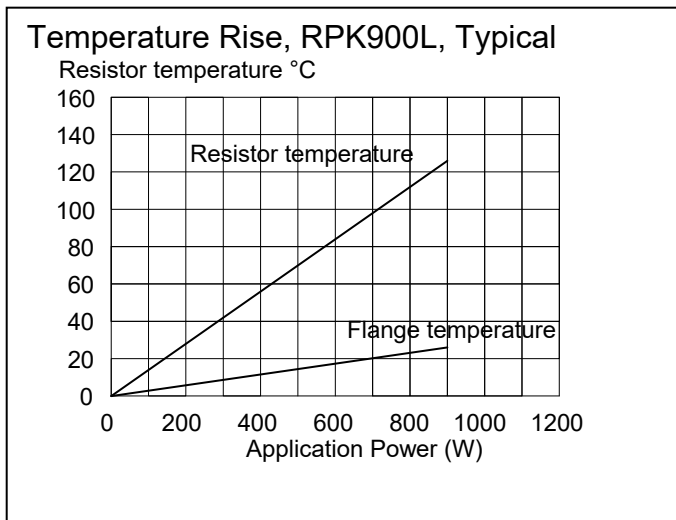
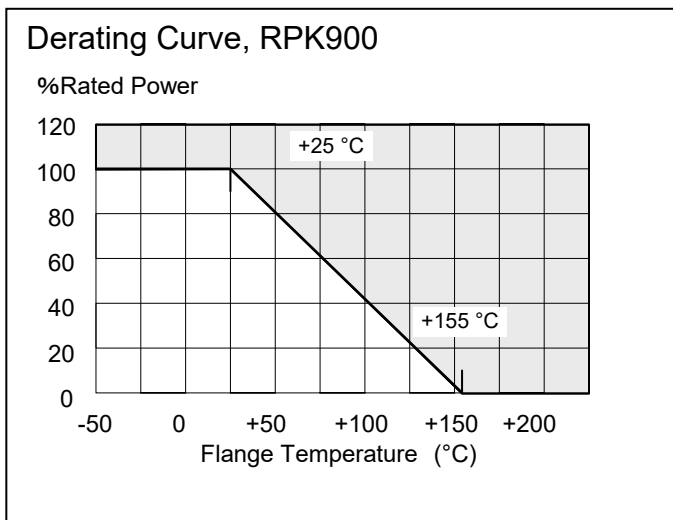

900W

CHASSIS MOUNTING NON-INDUCTIVE HIGH POWER RESISTORS

RPK900L

Pulse Operation

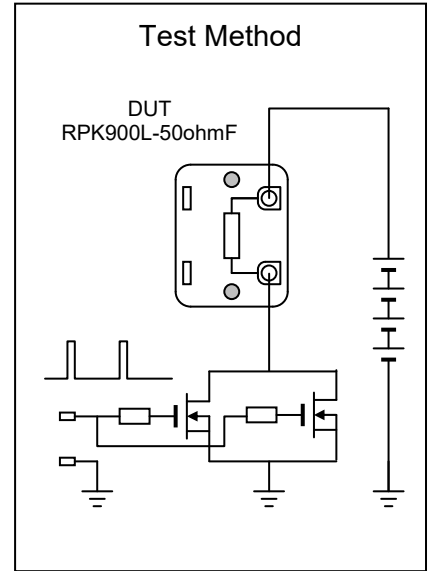
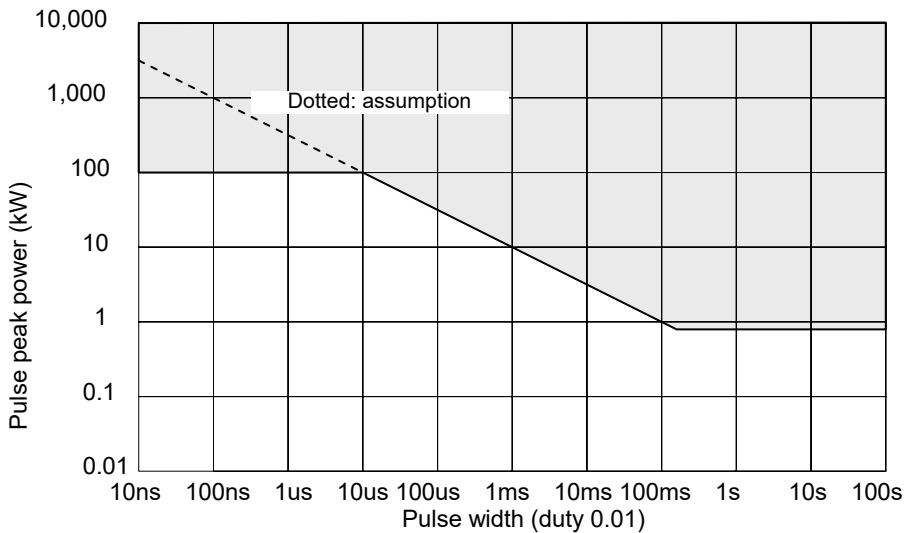

Above drawing shows allowable pulse peak power that obtained by actual breaking test of RPK900L-10ohm-J, and shows the result of double safety factor. The test was performed by observation of small resistance change after application of continuous pulse, that is rectangular waveform and 0.01 duty.

Since the pulse durability is moved by the resistance, the pulse waveforms and type of pulse source, constant voltage source or current source, please test carefully for long terms on actual electronics when operating the resistor by the pulse of the peak power exceeding rated power.

Typical High speed pulse power generator and water cooling resistor, RPK900L

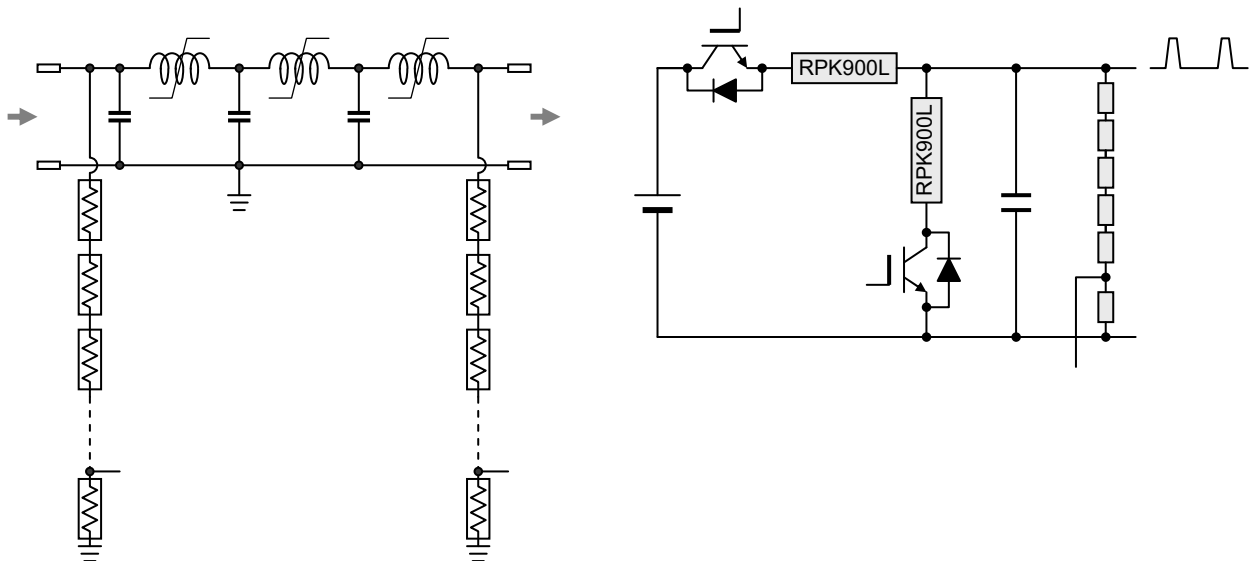

Typical High speed pulse power generator and water cooling resistor, RPK900L