

500W WATER COOLING NON-INDUCTIVE HIGH POWER RESISTORS

RPH500

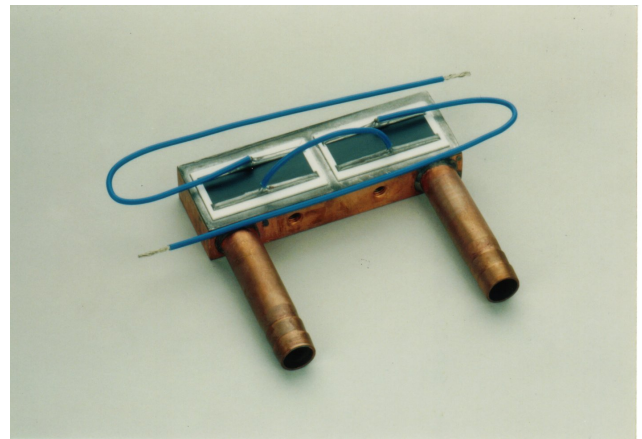

Features and Applications

Small sized 500W water-cooled non-inductive resistor with a very low resistor temperature under operation.

Flat plate resistance and twisted pair leads and special terminal structure (patent) are shown excellent surge absorption performances.

Resistors are insulated from case by the high purity alumina substrate, and are guaranteed to voltage-proof of 5kV.

Leads type, length, terminal processing (patented), and hose connection can be accepted arbitrary demands.

Surge suppression resistors for power thyristor and IGBT, used in power supply of electric power conversion system and of industrial apparatus, high output AC motor controls.

Dimensions (mm)

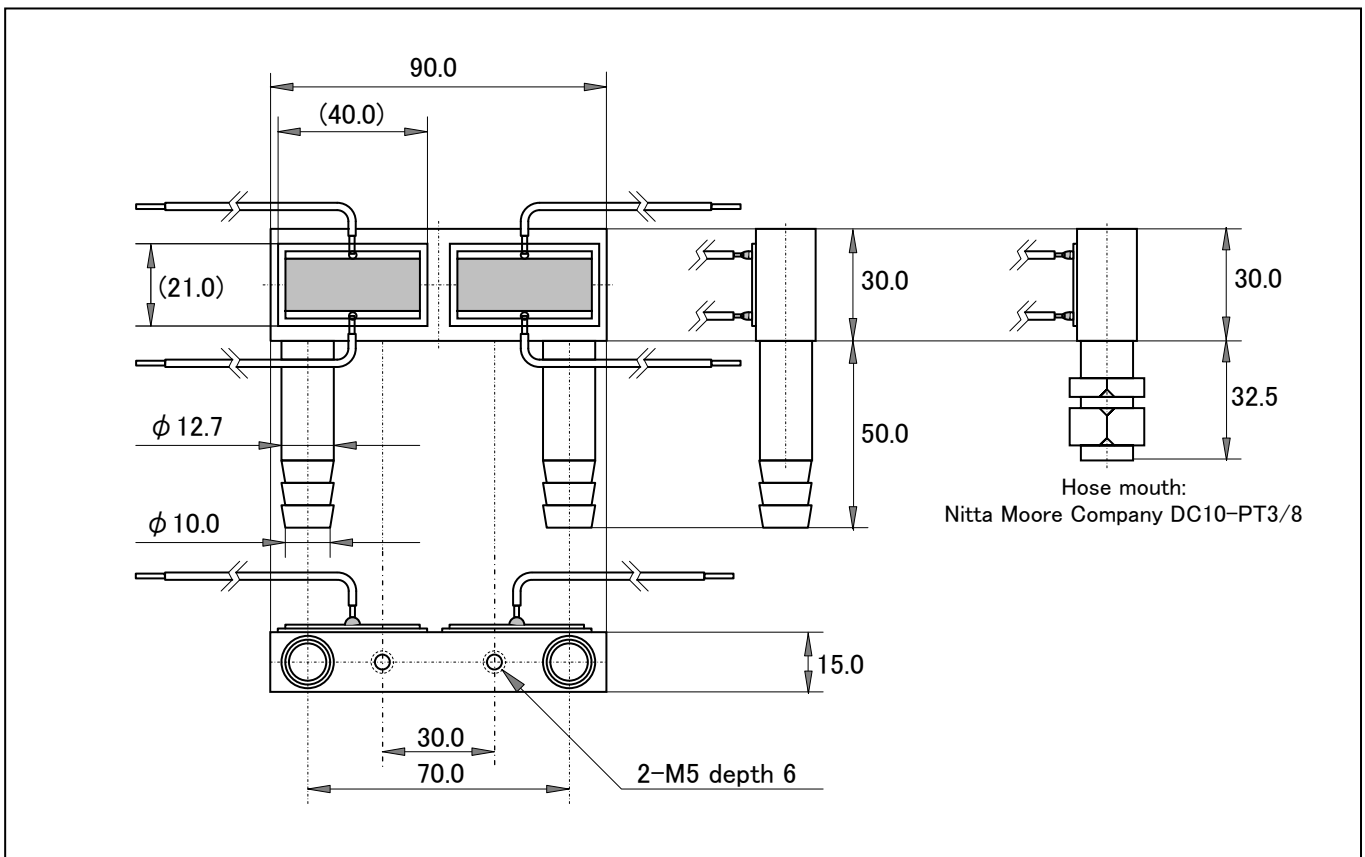

Specifications and Performances

	Specifications
Resistance	Any Value (odd value will be under MOQ 100pcs)
Resistance Range	0.1ohm-1Kohm
TCR	+/-250ppm/ degree C
Tolerance	+/-10%
Series Inductance	40nH/dual resistor, (Typical)
Parallel Capacitance	160pF/dual resistor, (Typical)
Hose Mouth	Standard: Nipple, any types are available.
Water Temperature	+41degreeC maximum at inlet, more than the dew point
Volume of Water Flow	2 liters/minutes minimum.
Water Pressure Loss	0.06Kg/(cm*cm)
Water Temperature Rise	1.4 degree C
Case Temperature Rise	14 degree C
Surface Temperature Rise	50 degree C
Surface Temperature Rise	Maximum 110 degree C
Rating Power	500W (250W/resistor element)
Max. Applied Power	700W (350W/resistor element)
Max. Continuous Impulse Load	Peak Power 37KW/10us/10KHz (Only for reference)
Damaged Impulse Load	100KW peak power/70us single and 37KW peak power/34us continuous.
Terminal Codes	Teflon Insulated Wire(0.18/30, outer diameter 2mm, Blue), 200mm length.
Dielectric Strength	AC2000V, 60 seconds. (Between terminals and case)
Max Operating Voltage	AC1000V
Insulation Resistance	1000Mohmminimum. (Between terminals and case)
Load Life	+/-2% (Rating 500W, 1000 hours)
Humidity	+/-2%(Rating*0.1, 1000hours, continuous load)
Weight	350 grams

Ordering Information

Model	TCR	Resistance	Tolerance	Remarks
RPH500	H	20 Ohm	K	
RPH500-000	H (250ppm/K)	0.1 Ohm-1k Ohm	K (+/-10%)	
RPH500-001				
RPH500-999				

xxx: 3 digits specified code from specification draw, please call factory

Schematics & Wiring

A resistor includes a couple of resistor elements and has following three ways connection. Series connection is standard, but if customer request specified connection and fly-lead length, please call our factory.

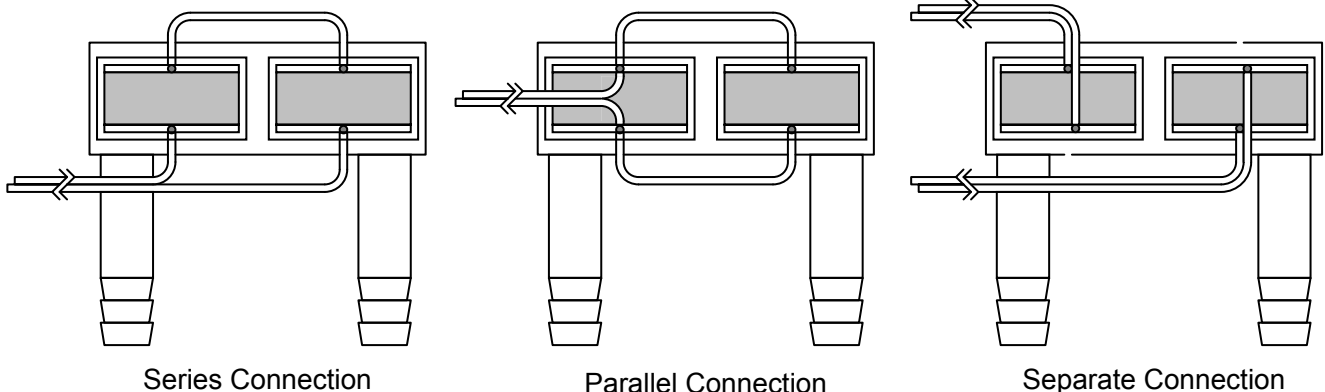

500W WATER COOL NON-INDUCTIVE HIGH POWER RESISTORS

RPH500

Temperature Rise Characteristics

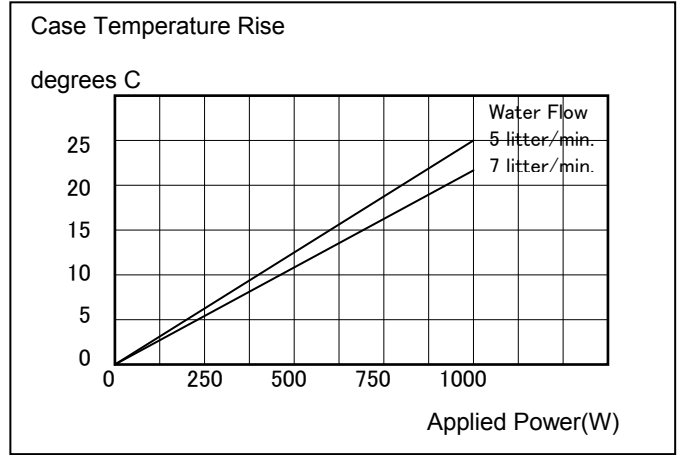
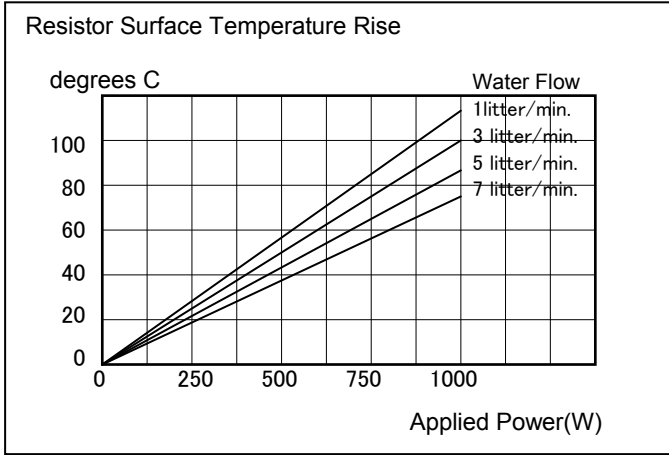

Recommended Long Life Actual Application of RPH500 snubber.

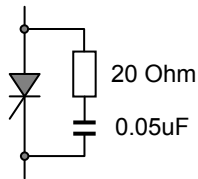
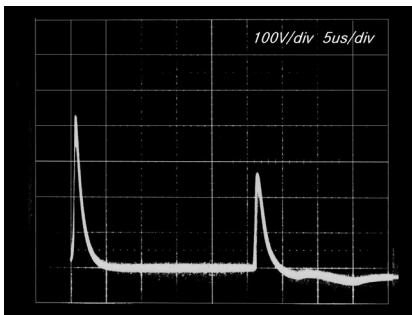

CR snubber for thyristor converter

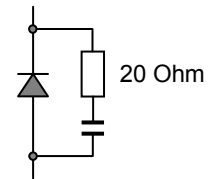
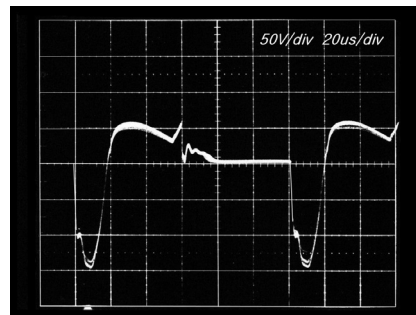

CRD snubber

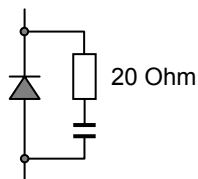
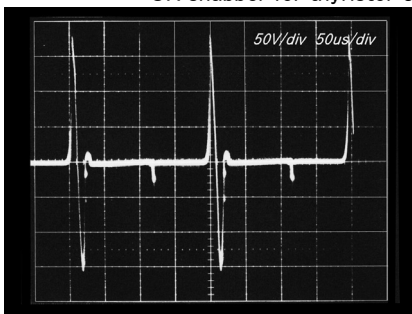

CRD snubber

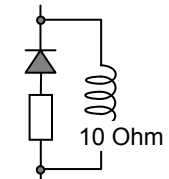
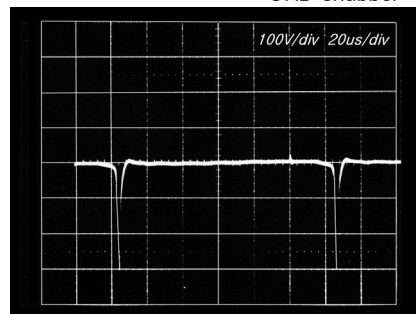

LRD snubber

