

TO220 50W HIGH POWER RESISTORS

RNP-50U

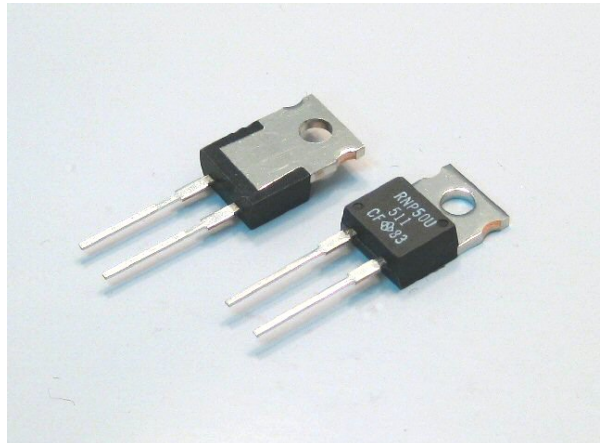

Features and Applications

50W high power resistors in TO220 style mold package for through-hole and screw mounting. AEC-Q200 test certified.

Non-inductive design suits high frequency applications and high-speed pulse circuits.

Low, 2.3 °C/W heat resistance from resistor hot spot to flange and long life performance are presented with thin film metallization technology and rejection of plastic adhesive joint.

Wide 20 milliohm to 510kohm wide resistance range, non-inductive impedance characteristic and heat conduction through the insulated metal flange aids circuit designers.

Small size and thin profile suit high-density compact installations.

Complete thermal conduction, heat dissipation design and vibration durable design also available.

Applications include snubber, gate control, bleeder, filter, rush current protection, braking resistors of automotive, rail traction, wind turbine, PV, UPS and motor control inverters.

Dimensional Specifications (mm)

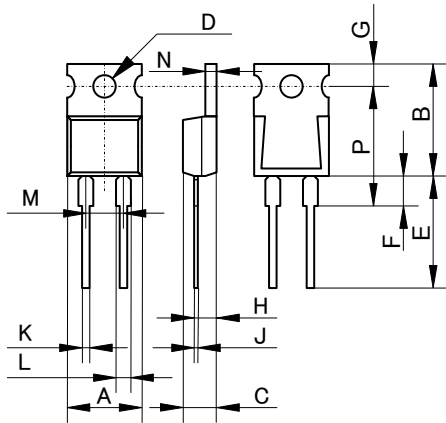

RNP-50U		
	mm	+/-mm
A	10.1	+/-0.2
B	15.0	+/-0.2
C	4.5	+/-0.2
D	3.6	+/-0.1
E	15.5	+/-1.0
F	4.0	+/-0.5
G	3.0	+/-0.2
H	2.75	+/-0.2
J	0.5	+/-0.05
K	0.75	+/-0.05
L	1.5	+/-0.05
M	5.08	+/-0.10
N	1.5	+/-0.05
P	16.0	+/-0.50

Structure and Material

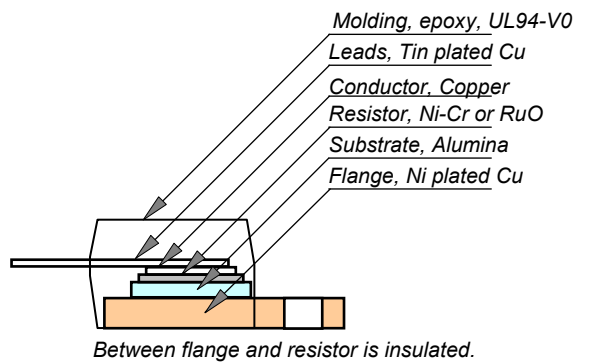

Ordering Information

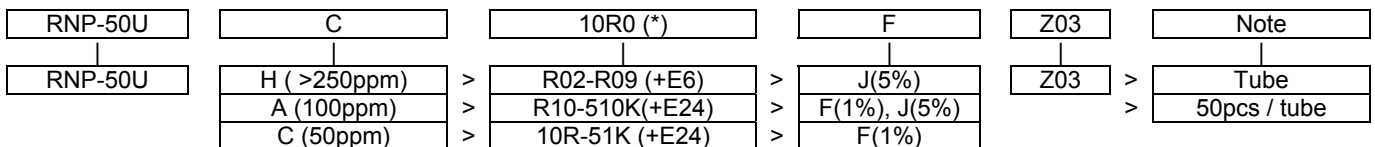

Resistance value (\*) is available following modified E24, +E24.

1.0	1.1	1.2	1.3	1.5	1.6	1.8	2.0	2.2	2.4	2.5	2.7	3.0	3.3
3.6	3.9	4.0	4.3	4.7	5.0	5.1	5.6	6.2	6.8	7.5	8.0	8.2	9.1

Note\*: When ordering, additional ohm resistance notation recommends for keeping out of misunderstanding.

TO220 50W HIGH POWER RESISTORS

RNP-50U

Specifications

		RNP-50U		Test Conditions
Rated Power	50 Watt			-55 °C to 25 °C flange temperature
Rating Power	1 Watt			Free air.
Heat Resistance	2.3 °C/W			Hot spot to flange
Resistance Range	0.02-0.09ohm	0.1-510 k ohm	10-51Kohm	Note 2
Nominal Resistance	E6	E24+	E24+	Include 2.5, 4.0, 5.0, 8.0 and 16
TCR, ppm/°C	>250 (H)	100 (A)	50 (C)	Note 3
Tolerance	5%(J)	1% (F), 5% (J)	+/-1% (F)	1% tolerance at 0.01-0.091 ohm is available optionally.
Resistor Material	Thick Film		Thin Film	
Capacitance	1.69pF			Equivalent parallel capacitance.
Inductance	9.65nH			Equivalent series inductance
Operation Temp.	-55 °C to +175 °C			
Max. Operating Volt.	smaller either 700V or $\sqrt{P \times R}$			P is rating power and R resistance
Withstanding Voltage	2000VAC			Terminal and flange, 60 seconds, 1mA
Load Life	+/- 1.0 %			25 °C, 90 min. ON, 30 min. OFF, 1000 hours.
Humidity	+/- 1.0 %			40 °C, 90-95%RH, DC 0.1W, 1000 hours.
Temp. Cycle	+/- 0.25 %			-55 °C,30 min.,+155 °C,30 min., 5cycles
Soldering Heat	+/- 0.1 %			350+/-5 °C, 3seconds,
Solder ability	Over 95% of surface			230+/-5 °C, 3seconds.
Insulation Resistance	Over 1,000 Meg ohm			Between terminals and flange.
Vibration	+/- 0.25 %			IEC60068-2-6, see note 4
Weight	2.1 grams			

Derating

Rating Power (W)

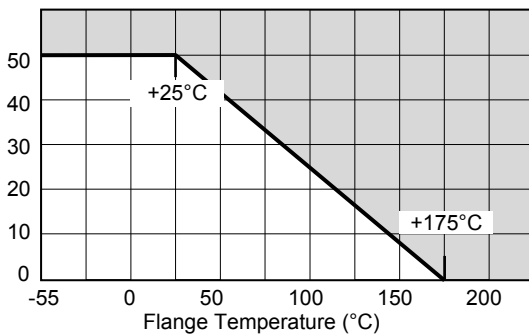

Temperature Rise

Temperature Rise (°C)

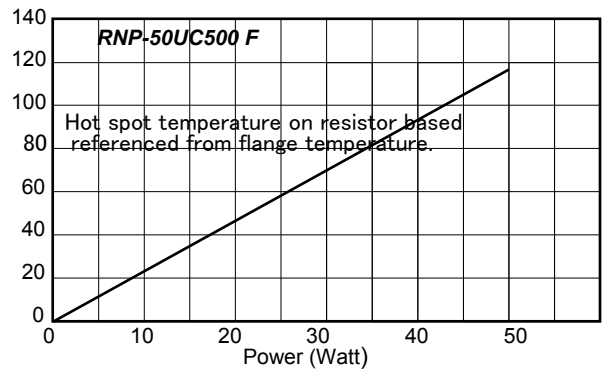

Pulse Energy Durability

Pulse peak power (W)

Applied to RNP-50UC10ohmF and resistance < 100ohm

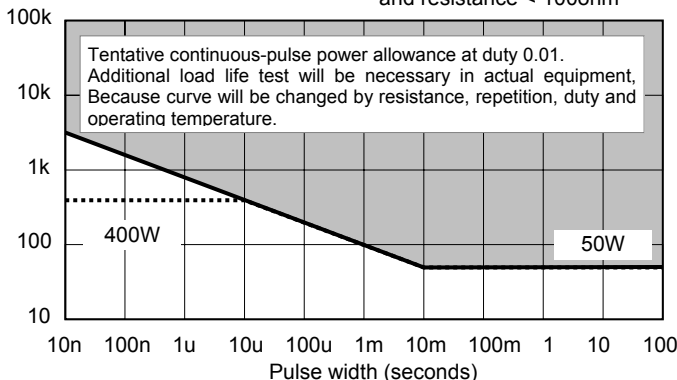

Frequency Characteristics

Impedance (ohm)

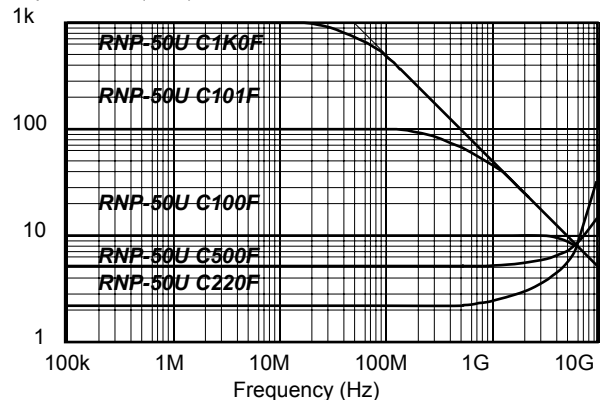

Note:

- Insulation material is unnecessary between flange and heat-sink, flange and resistor is separated by alumina substrate.
- Resistance measurement shall be made at a point 5.27mm +/-0.6 mm from the resistor body.
- TCR of low resistance will be increased as 300ppm/0.02ohm, 200ppm/0.05ohm, 140ppm/0.1ohm and 80ppm/0.2ohm typically. Testing point is at 5.27mm from bottom of molding of terminals.
- Test method is IEC60068-2-6, and specification is sine sweep wave form, 100Hz-2000Hz, 10 cycles, amplitude 0.75mm or 100m/s<sup>2</sup>, 90minutes. direction x-y z, Amplitude 0.75mm will be applied under break point Frequency (about 60Hz) and 100m/s<sup>2</sup> over break point
- When mounting resistor on heat-sink by screw, clip and pressure strip with using heat conduction grease on back side of resistor are recommended. Recommended screw torque is 0.5-0.6Nm.
- Standard packaging is anti-static PE tray, which contains 100pcs / tray.

20161101