

45W
SMD SURGE PROTECTION RESISTOR
RNP-45

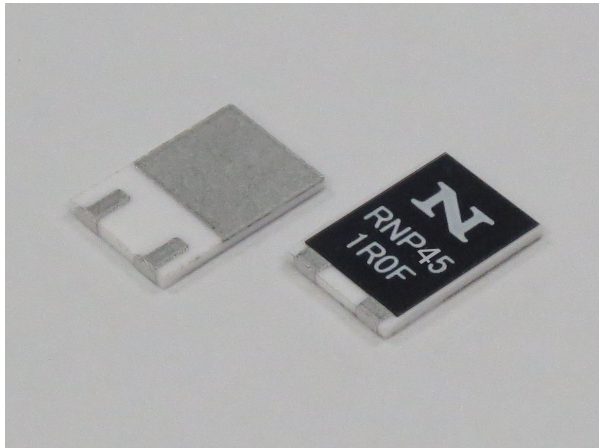

Features and Applications

- Very small size, low profile, right weight SMD surge protection power film resistors.
- 55°C to +175°C temperature range provides for automotive applications.
- Low thermal resistance under 3.0 °C/W shows excellent cooling performance.
- Easy to replace D-PAK power resistor.
- Excellent rf characteristics advantage to high speed pulse operation.
- Applications include snubber, gate control, bleeder, filter, rush current protection, braking resistors of automotive, rail traction, wind turbine, PV, UPS and motor control inverters.

Dimensions, Foot Pattern and Materials (mm)

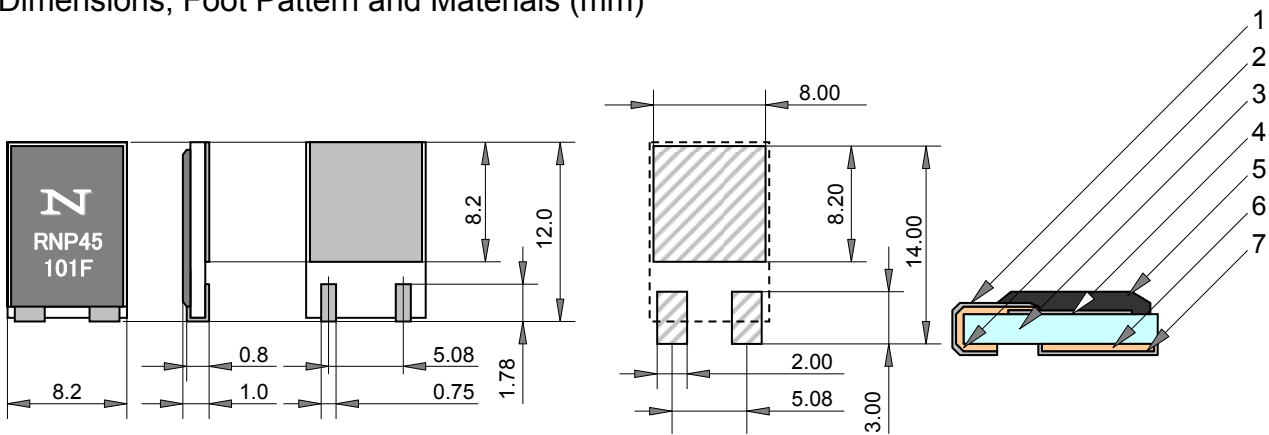

	substance	material
1	terminals	Pd-Ag film, Ni plating & Tin plating
2	terminals	Copper, Ni plating & Tin plating
3	substrate	ALO 1mm thickness
4	resistor	Ni-Cr alloy
5	molding	Epoxy resin, UL-94 V-0
6	heat sink	Pd-Ag film, Ni plating & Tin plating
7	heat sink	Pd-Ag film, Ni plating & Tin plating

Ordering Information

Type RNP-45	blank -	Resistance 100 Ohm	Tolerance F*	Code Z01	Remarks
RNP-45	-	0.02 Ohm- 510k Ohm E24+	F(1%)*	Z01	Tape reel

Recommend resistance E24+

1.0	1.1	1.2	1.3	1.5	1.6	1.8	2.0	2.2	2.4	2.5	2.7	3.0	3.3
3.6	3.9	4.0	4.3	4.7	5.0	5.1	5.6	6.2	6.8	7.5	8.0	8.2	9.1

(*) Tolerance of 0.02ohm to 0.091ohm will be +/-5% only.

45W SMD POWER CHIP RESISTOR, RNP-45

Specifications

	RNP-45	Test Conditions
Rating Power	45 Watts	-55 °C to 25 °C backing metal temperature
Rating Power	1.0 Watts	Attached on simple foot print.
Short Time Overload	50W	Rated power X 2.0 and 5 second at 25°C with heat-sink
Heat Resistance	3.0 °C/W	Resistor to back metal
Resistance Range	0.02 Ohm – 510k Ohm	0.02ohm-0.91ohm are available at 5% tolerance only.
Nominal	E24+	Include 2.5, 4.0, 5.0, 8.0 and 16
TCR	100 ppm/°C	10ohm to 51kohm, around 100 ppm/°C under 9.1ohm
Tolerance	+/-1% (F)	
Resistor Material	Thick Film	
Capacitance	2.65 pF	Equivalent parallel capacitance, typical
Inductance	14.65 nH	Equivalent series inductance, typical
Operation Temp.	-55 °C to +175 °C	
Max. Operating Current	10A	
Max. Operating Volt.	less than 500V or $\sqrt{P \cdot R}$	P is rating power and R resistance
Withstanding Volt.	1500 VAC	Terminal and back metal, 60 seconds. 1mA
Load Life	+/- 1.0 %	25 °C, 90 min. ON, 30 min. OFF, 1000h.
Humidity	+/- 1.0 %	40 °C, 90-95%RH, DC 0.1W, 1000 hours.
Temp. Cycle	+/- 0.25 %	-55 °C, 30 min., +155 °C, 30 min., 5cycle
Soldering Heat	+/- 0.1 %	350+/-5 °C, 3seconds,
Lead Solder ability	Over 95% of surface	230+/-5 °C, 3seconds.
Insulation Resistance	Over 1,000 Meg ohm	Between terminals and back metal.
Vibration	+/- 0.25 %	IEC60068-2-6, see note 4
Weight	0.324 gram	

Power Derating

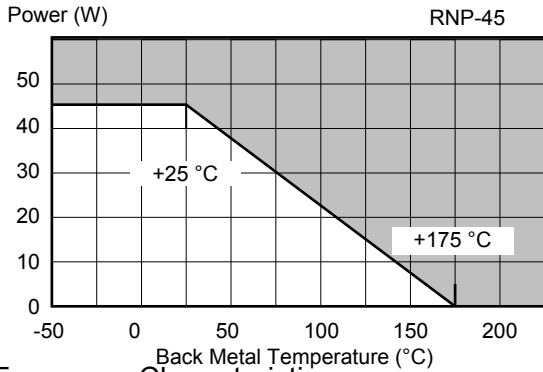

Pulse Energy Durability

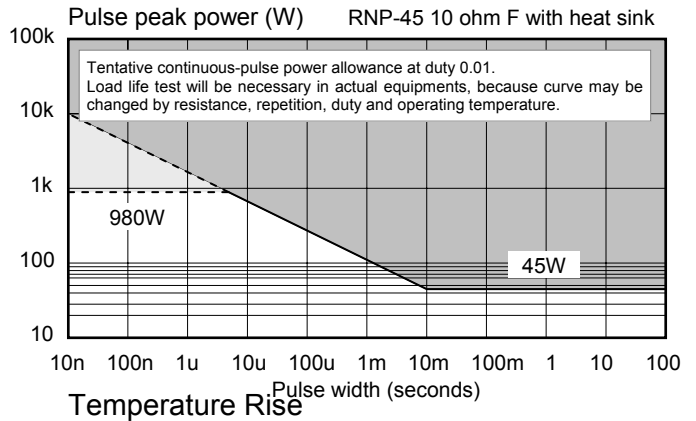

Frequency Characteristics

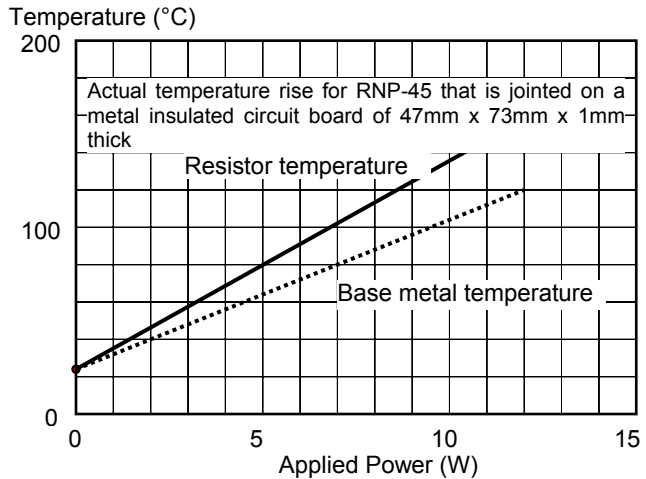
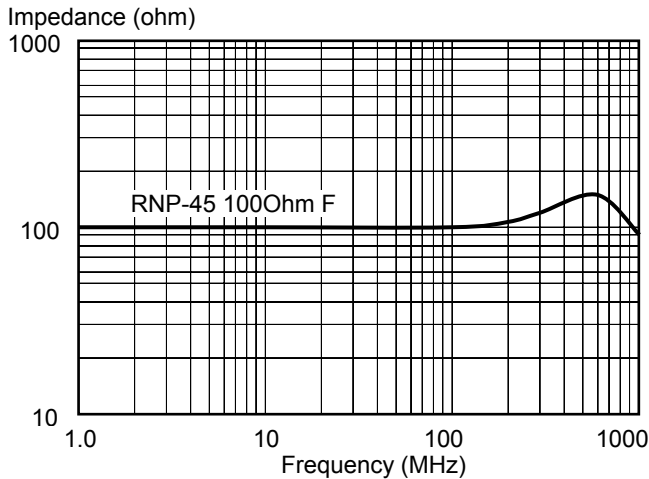

45W SMD POWER CHIP RESISTOR, RNP-45

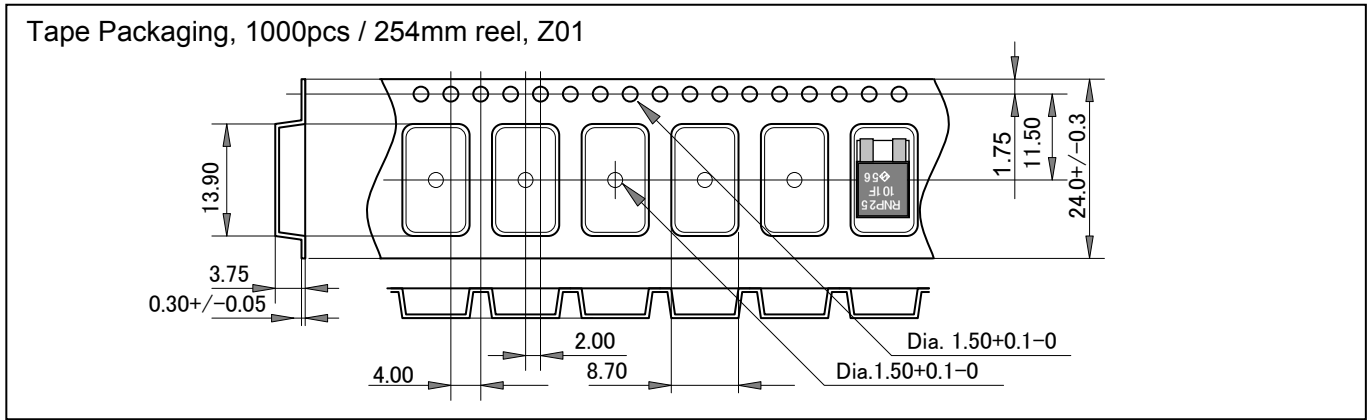

Applications

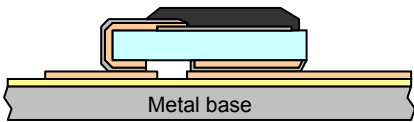

Metal insulated circuit board improves thermal absorption performance from resistor to heat-sink.

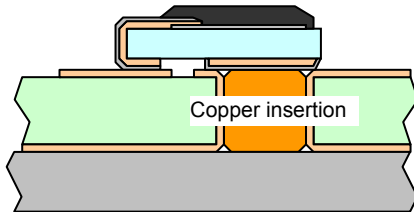

Copper insertion improves thermal absorption performance from resistor to heat-sink. Please be careful to relax the differences of coefficient of expansion between printed circuit board and alumina.

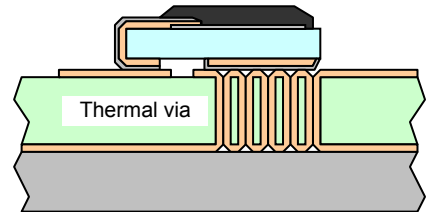

Thermal via improves thermal absorption performance from resistor to heat-sink. Please be careful to relax the differences of coefficient of expansion between printed circuit board and alumina.

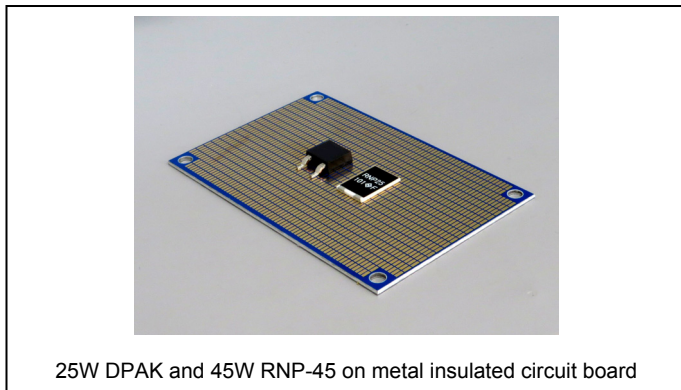
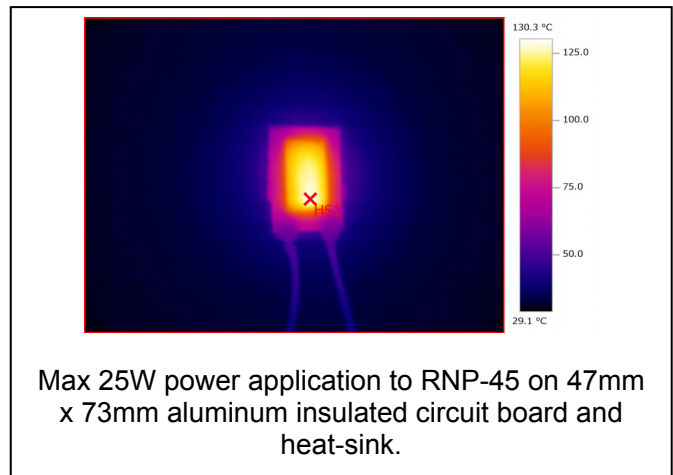
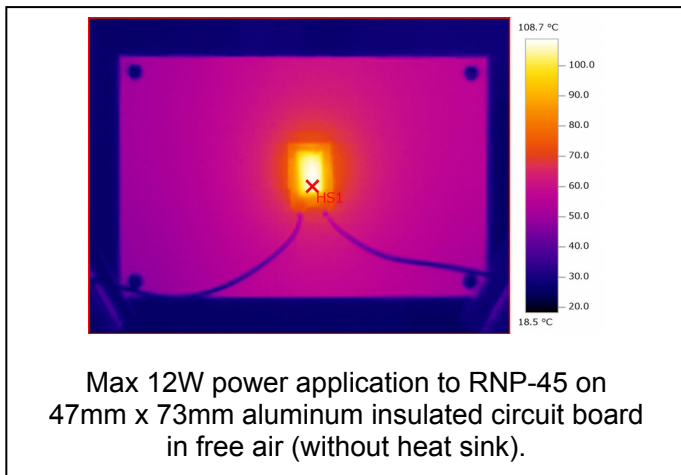

For your reference
 Thermal resistance between resistor area to base metal of RNP-45 is 3.0 °C/W.
 Vertical thermal resistance of FR4 both side copper printed circuit board with 1.5 mm thickness and 1.0 inch square is approximately 10 °C/W.
 Thermal resistance of the single thermal via with dimension of 0.5mm diameter and 1.5mm length is around 100 °C/W, when 16 pieces of thermal via under base metal portion of resistor realize 6.25 °C/W.