

TO263 SURFACE MOUNT
50W HIGH POWER RESISTORS
RNP-50F

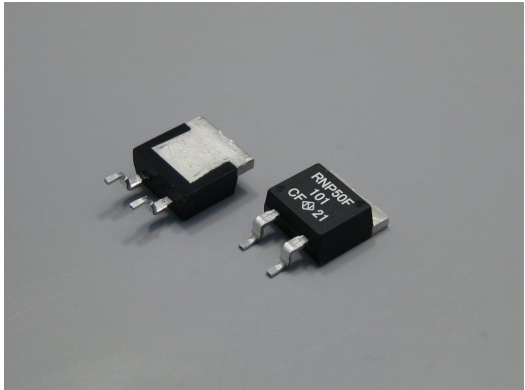

Features and Applications

50W high power resistors, high soldering temperature in TO263 (D2PAK) style surface mount mold package with matte Tin plated flange.
Non-inductive design suits high frequency applications and high-speed pulse circuits.
Low, 2.3 °C/W heat resistance from resistor hot spot to flange and long life performance are presented with thin film metallization technology.
Wide, 20 mΩ to 51K Ω resistance range, non-inductive impedance characteristic and heat extracting through insulated metal flange aids circuit designers.
Applications for UPS, power unit of machines, motor control, drive circuits, automotive, measurements, industrial computers and high frequency electronics.

Dimensional Specifications (mm)

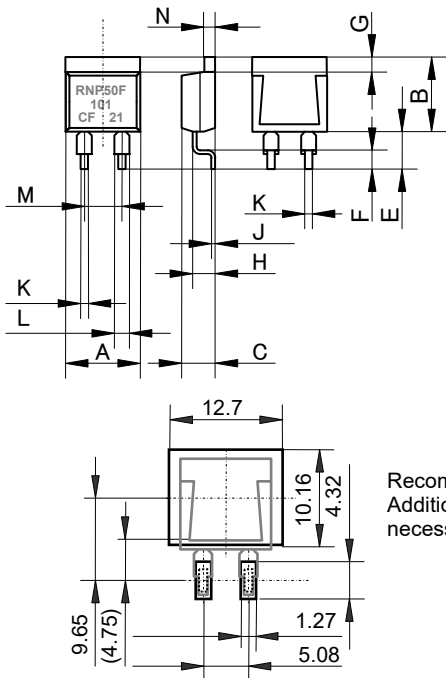

RNP-50F		
	mm	+/-mm
A	10.1	+/-0.2
B	10.3	+/-0.2
C	4.5	+/-0.2
D	-	-
E	5.0	+/-1.0
F	2.5	+/-0.5
G	2.2	+/-0.2
H	2.75	+/-0.2
J	0.5	+/-0.05
K	0.75	+/-0.05
L	1.5	+/-0.05
M	5.08	+/-0.10
N	1.5	+/-0.05

Recommended Land Pattern. (mm)
Additional heat cooling system will be necessary

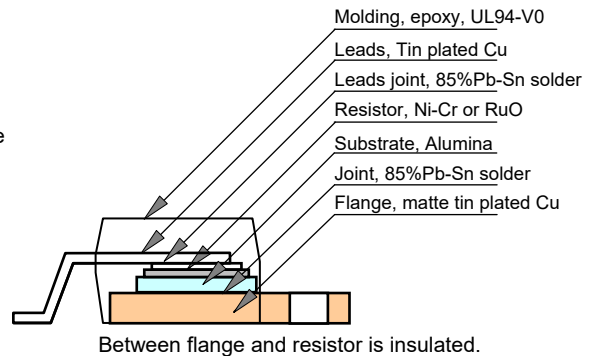
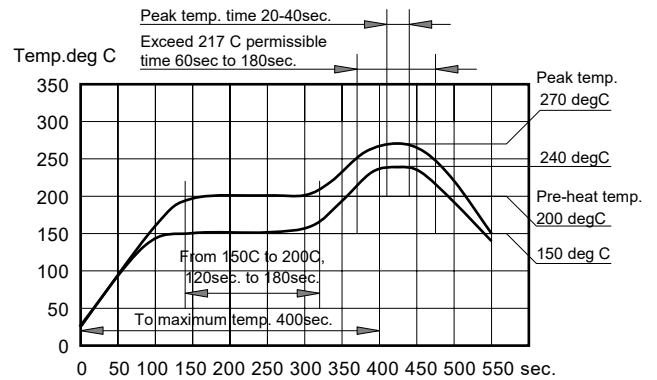

Ordering Information

RNP-50F	A	1R0	F	Z01	Tape & Reel
RNP-50F	H(>250ppm) A(100ppm) C(50ppm)	R02 to R10 R10 to 510K 10R to 51K	J (5%) J / F (1%) F(1%)	Z01(Tape) Z03(Tray) Z05(Tray) *	Z: RoHS 2

* TO263 type resistor packaging Z05 (tray) has a risk of loss of flatness, co-planarity.
Resistance value (*) is available following modified E24, +E24.

1.0	1.1	1.2	1.3	1.5	1.6	1.8	2.0	2.2	2.4	2.5	2.7	3.0	3.3
3.6	3.9	4.0	4.3	4.7	5.0	5.1	5.6	6.2	6.8	7.5	8.0	8.2	9.1

TO263 SMD 50W HIGH POWER RESISTORS

RNP-50F

Specifications

	RNP-50F			Test Conditions
Rating Power	50 Watt			-55 °C to 25 °C flange temperature
Rating Power	2 Watt			Attached on simple foot print.
Heat Resistance	2.3 °C/W			Resistor hot spot to flange
Resistance Range	0.02 - 0.091Ω	0.1 - 510KΩ	10 - 51KΩ	Note 2
Nominal	E6	E24	E24	Include 2.5, 4.0, 5.0, 8.0 and 16
TCR (ppm/°C)	250(H)	100 (A)	50 (C)	Note 3.
Tolerance	5%(J)	1% (F) 5% (J)	+/-1% (F)	1% tolerance at 0.01-0.091 Ω are available.
Resistor materials	Thick film		Thin film	100 ppm/°C thick film are available in 10Ω-51kΩ
Capacitance	1.44pF			Equivalent parallel capacitance.
Inductance	8.38nH			Equivalent series inductance
Category Temp. Range	-55 °C to +155 °C			
Max. Element Volt.	Either 500V or $\sqrt{P \cdot R}$			P is rating power and R resistance
Voltage Proof	2000 VAC			Terminal and flange, 60 seconds. 1mA
Load Life	+/- 1.0 %			25 °C, 90 min.ON, 30 min. OFF, 1000h.
Humidity	+/- 1.0 %			40 °C, 90-95%RH, DC 0.1W, 1000 hours.
Temp. Cycle	+/- 0.25 %			-55 °C,30 min.,+155 °C,30 min., 5cyc
Soldering Heat	+/- 0.1 %			350+/-5 °C, 3seconds,
Lead Solder ability	Over 95% of surface			245+/-5 °C, 3seconds.
Insulation Resistance	Over 1,000 Meg Ω			Between terminals and tab.
Vibration	+/- 0.25 %			IEC60068-2-6, see note 4
Flammability	UL94-V0			
Weight	1.5 grams			

Power Derating

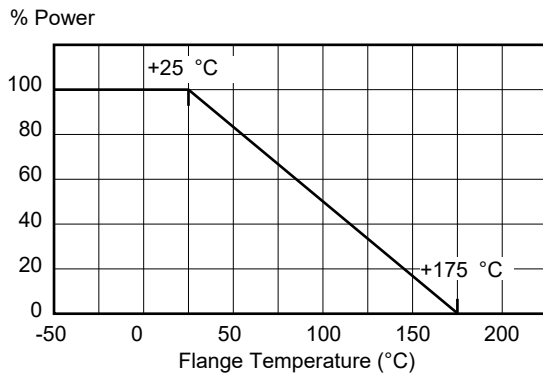

Pulse Energy Durability

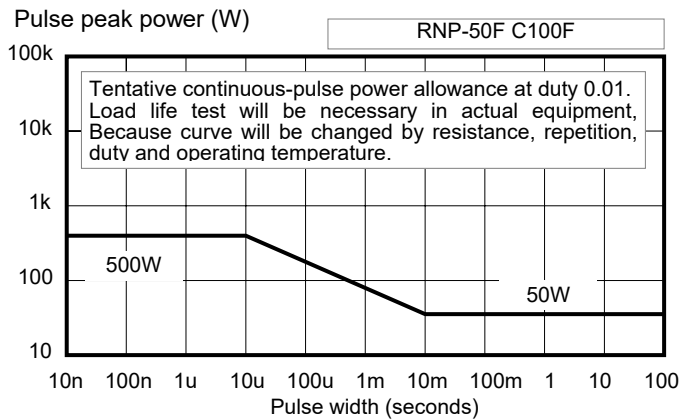

Tape Dimension

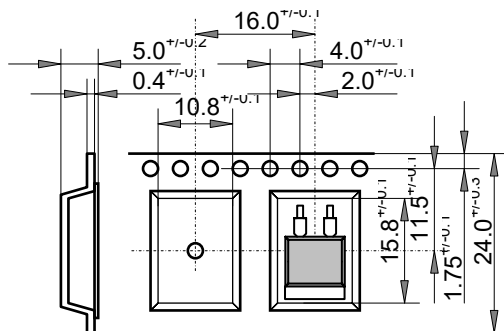

Reel Dimension

Outer diameter: 330 mm
 Inner diameter: 100 mm
 Width: 23.9 mm min. 27.4 mm max
 Package quantity: 500pcs/13 inches reel

Note:

- (1) Flange insulation is not necessary between flange and heat-sink, flange and resistor is separated by alumina substrate.
- (2) Resistance measurement shall be made at terminal foot portion.
- (3) TCR of low resistance will be increased as 300ppm/0.02Ω, 200ppm/0.05Ω, 140ppm/0.1Ω and 80ppm/0.2Ω typically. Testing point is at 5.27mm from bottom of molding of terminals.
- (4) Test method is IEC60068-2-6, and specification is sine sweep wave form, 100Hz-2000Hz, 10 cycles, amplitude 0.75mm or 100m/s², 90minutes. direction x-y z, Amplitude 0.75mm will be applied under break point frequency (about 60Hz) and 100m/s² over break point
- (5) Standard packaging is tape reel, a tape reel contains 500pcs. In case of small quantity, tube packaging 50pcs/tube or tray 100pcs/tray are available, the tube and tray are made by RoHS PS/PE which contains 50pcs / tube.

20210101