

250mW  
 SURFACE MOUNT 50 ohm  
 RF ATTENUATORS  
 RFA1206

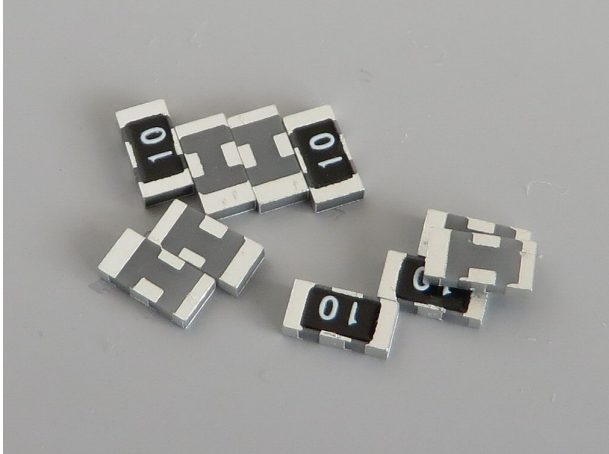

Features and Applications

Small size (1206), high performance, balanced attenuator.  
 6db, 8db, 10db, 20db are available.  
 250mW power handling.  
 50 ohm characteristic impedance and wide frequency range  
 Dc to 5.0GHz.

Pb free, RoHS compliant and BeO free configuration.

Long life and temperature stability by thin film technology

Applications include power detect circuit of isolator, gain control circuits, isolation circuits of power boost amplifiers at GHz, loss compensation of transmission line of data communication systems, detecting signal control of ATE-LSI test system-circuit board functional test systems, industrial measurement electronics, medical scientific electronics and aero space.

Dimensions, Materials, Foot Pattern and Pin#

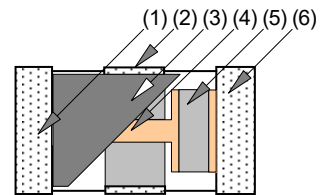
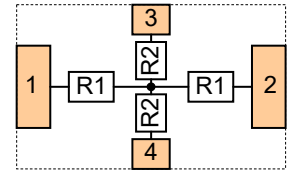
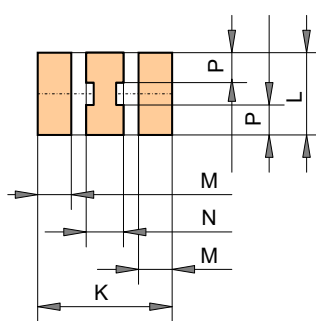
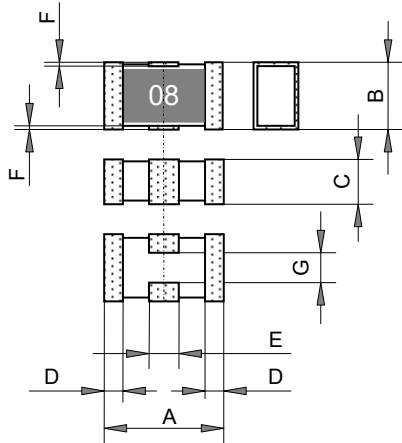

	inch	mm	Tol (mm)
A	0.126	3.20	+/-0.08
B	0.063	1.60	+/-0.08
C	0.025	0.63	+/-0.08
D	0.020	0.51	+/-0.08
E	0.032	0.81	+/-0.08
F	0.009	0.23	+/-0.08
G	(0.032)	(0.81)	+/-0.08

	inch	mm	Tol (mm)
K	0.142	3.60	+/-0.08
L	0.079	2.00	+/-0.08
M	0.036	0.90	+/-0.08
N	0.039	1.00	+/-0.08
P	0.031	0.80	+/-0.08

	Substances	Materials
(1)	Input Conductor	Cu-Ni-Tin plating
(2)	Side Conductor	Cu-Ni-Tin plating
(3)	Passivation	Epoxy resin
(4)	Inside Conductor	Ni-Cr Cu sputtering
(5)	Thin Film Resistor	Ni-Cr alloy
(6)	Output Conductor	Cu-Ni-Tin plating

Note: Side conductor is build on ALN substrate and sputtering Ni-Cr, sputtering Cu, electro-plated Ni, electro-plated Tin.

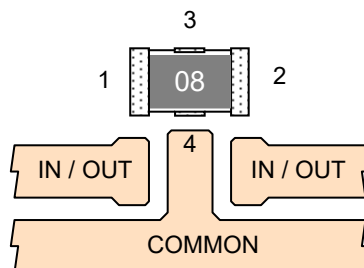

# SURFACE MOUNT RF ATTENUATORS, 250mW

RFA1206

## Ordering Information

Type	---	Attenuation	Code	Note
RFA1206	---	20dB	Z01	
RFA1206	---	6dB	Z00	Bulk
		8dB	Z01	Tape and reel
		10dB		
		20dB		

## Specifications and Performances

Items	Specifications	Conditions
Attenuation	6db, 8db, 10db, 20db	
Attenuation tolerance	+/-0.4dB	Output DC volt in terminating out put with resistor when stable 1V DC volt source connect to input.
Characteristic Impedance	50 Ohms	
Tolerance of Impedance	+/- 2%	Input DC resistance in terminating output with resistor.
TC of Impedance	+/- 50ppm/°C	TC of input DC resistance in terminating output with resistor.
TC of Attenuation	+/- 50ppm/°C	TC of output DC volt in terminating out put with resistor when stable 1V DC volt source connect to input.
Rating Power	250 mW	Input Power
Rating Temperature	-55-100 °C	
Soldering Heat	+/- 1%	350C, 3 seconds dipping.
Soldering capability	95% covered	
Humidity	+/- 1% impedance	Input DC resistance change Under condition of 40C temp and 90-95%RH, rating power ON-90min, OFF-30min, 1000h
Load Life	+/- 1% impedance	Input DC resistance change. Under condition of 70C temp, rating power ON-90min, OFF-30min, 1000h
Operating Temperature	-55 °C - +155 °C	
Storage Temperature	-55 °C - +80 °C	

## Derating

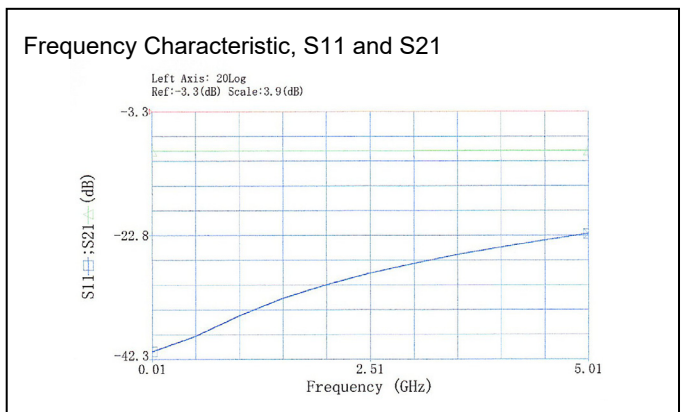
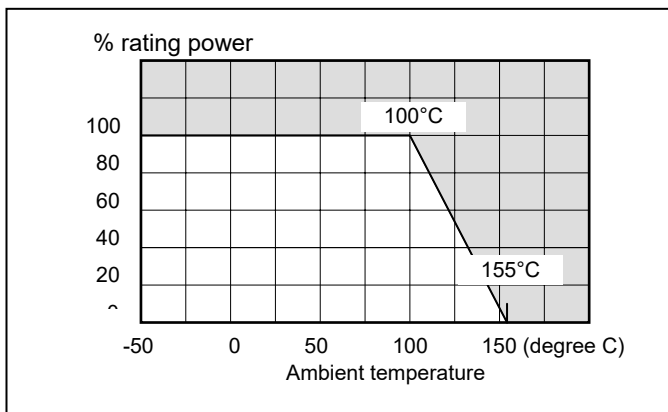

Note: Transformation:  $VSWR = \frac{1+|\Gamma|}{1-|\Gamma|}$  .....  $|\Gamma| = 10^{\frac{S11}{20}}$   $|\Gamma| = \frac{VSWR - 1}{VSWR + 1}$  .....  $S11 = -(-20 \log |\Gamma|)$

20201101