

1/4W, 1/2W, 1W, 2W Thin Film Precision Chip
 R1206, R1210, R2010, R2512, R3020

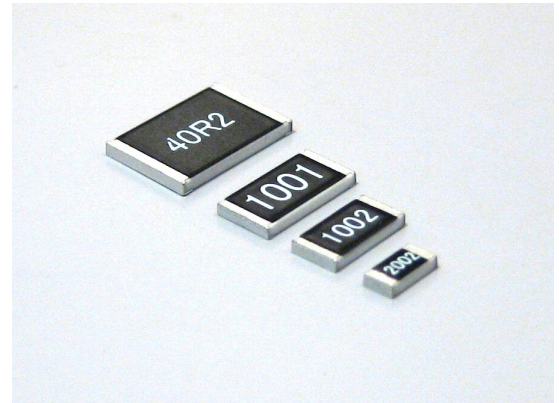

Features and Applications

Thin film precision chip resistor, 5 ppm/°C TCR and 0.05 % tolerance is in standard.
 Ni-Cr alloy thin film resistor, which is made by the advanced Nikkohm process deposited on alumina ceramic substrate and offer the features of long term stability and very low TC.
 Applications: Industrial measurement, control electronics and automatic test equipment.

Dimensional Specifications (mm)

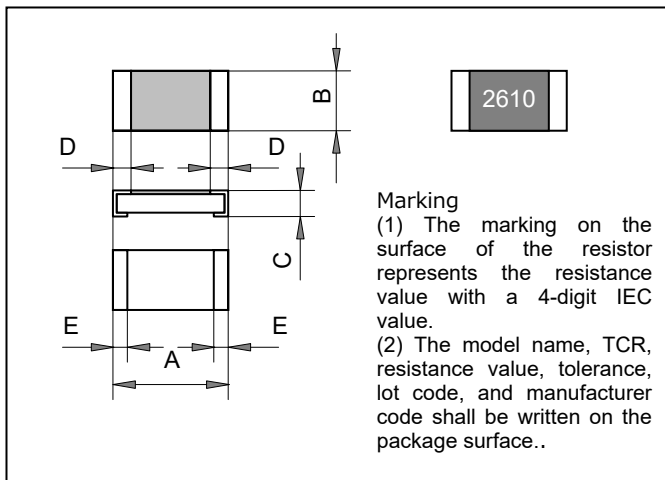

Materials

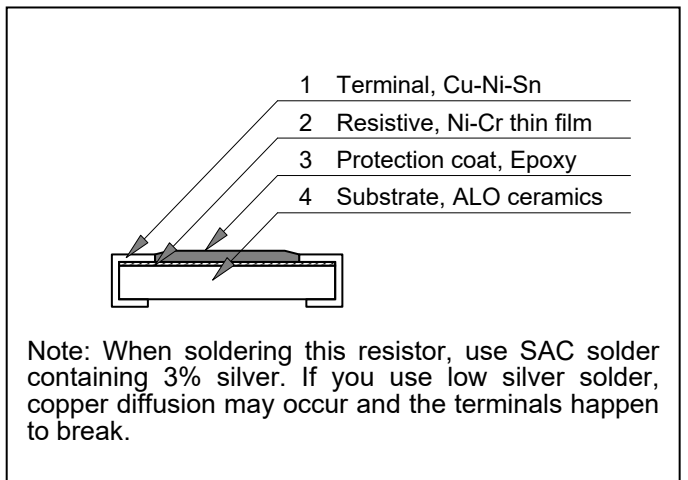

	R1206-0.25W	R1210-0.25W	R2010-0.5W	R2512-1W	R3020-2W
A	3.05+/-0.2	3.05+/-0.2	5.08+/-0.2	6.35+/-0.2	7.62+/-0.2
B	1.53+/-0.2	2.54+/-0.2	2.54+/-0.2	3.05+/-0.2	5.08+/-0.2
C	0.70+/-0.1	0.70+/-0.1	0.70+/-0.1	0.70+/-0.1	0.70+/-0.1
D	0.41+/-0.3	0.41+/-0.3	0.58+/-0.3	0.58+/-0.3	0.58+/-0.3
E	0.36+/-0.2	0.36+/-0.2	0.51+/-0.2	0.51+/-0.25	0.51+/-0.25

Ordering Information

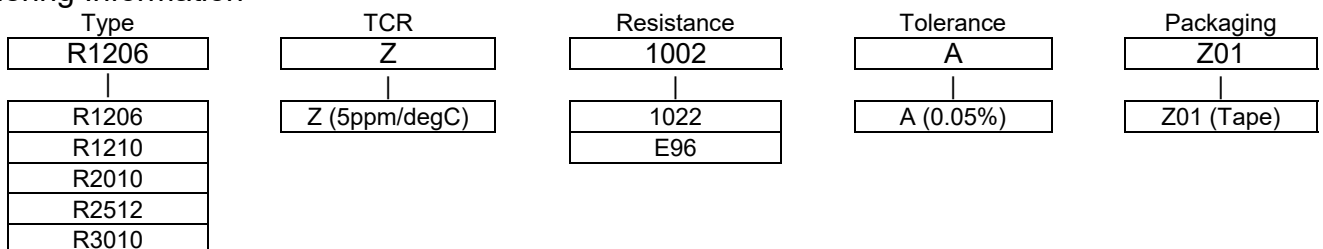

1/4W, 1/2W, 1W, 2W Precision Chip

R1206, R1210, R2010, R2512, R3020

Resistance Value, E24+ and E96+

1.00	1.02	1.05	1.07	1.10	1.13	1.15	1.18	1.20	1.21	1.24	1.27	1.30	1.33	1.37	1.40	1.43	1.47	1.50	1.54
1.58	1.60	1.62	1.65	1.69	1.74	1.78	1.80	1.82	1.87	1.91	1.96	2.00	2.05	2.10	2.15	2.20	2.21	2.26	2.32
2.37	2.40	2.43	2.49	2.50	2.55	2.61	2.67	2.70	2.74	2.80	2.87	2.94	3.00	3.01	3.09	3.16	3.24	3.30	3.32
3.40	3.48	3.57	3.60	3.65	3.74	3.83	3.90	3.92	4.02	4.12	4.22	4.30	4.32	4.42	4.53	4.64	4.70	4.75	4.87
4.99	5.00	5.10	5.11	5.23	5.36	5.49	5.60	5.62	5.76	5.90	6.04	6.19	6.20	6.34	6.49	6.65	6.80	6.81	6.98
7.15	7.32	7.50	7.68	7.87	8.06	8.20	8.25	8.45	8.66	8.87	9.09	9.10	9.31	9.53	9.76				

TCR and Tolerance Identifications

TCR	
TCR	Symbols
+/- 5ppm/C	Z

Tolerance	
Tolerance	Symbols
+/- 0.05%	A

Specifications

	R1206	R1210	R2010	R2512	R3020
Resistance	25-50Kohm	25-50Kohm	25-50Kohm	25-50Kohm	25-50Kohm
TCR	+/-5ppm(Z)	+/-5ppm(Z)	+/-5ppm(Z)	+/-5ppm(Z)	+/-5ppm(Z)
Tolerance	+/-0.05%(A)	+/-0.05%(A)	+/-0.05%(A)	+/-0.05%(A)	+/-0.05%(A)
Resistance Value	E96, E24	E96, E24	E96, E24	E96, E24	E96, E24
Rating Powers	0.25W	0.25W	0.5W	1.0W	2W
Max. Working Voltages	Less than 50V DC or $E = \sqrt{P \cdot R}$				
Max, Working Current	Less than 500mA or $I = \sqrt{(I^2 / R)}$				
Operating Temp.	-25 °C to +120 °C				
Storage Temp.	-25 °C to +120 °C				

The resistance less than 5 ohm could supply in 25ppm TCR-0.1%Tolerance. Please call factory.

Performances

	R1206, R1210, R2010, R2512, R3020	条件 Conditions
Short Time Overload	+/- 0.05%	2.5 times rated power, 5seconds, one time
Insulating Voltage	+/- 0.01%	
Withstanding Voltage	+/- 0.01%	
Heat Shock	+/- 0.05%	
Vibration	+/- 0.01%	
Soldering Heat	+/- 0.05%	260 °C, 10+/-1seconds.
Solder ability	90%	
Solvent	None	
Terminal Strength	+/- 0.05%	
Humidity	+/- 0.05%	40°C , 90-95RH, DC0.1W, 1000hours
Load Life	+/- 0.05%	70 °C, Rated Power, 90min ON, 30min OFF, 1000hours
Thermal EMF	---	
PCT	+/-0.05%	100H, Typical
Long Term Stability	+/-50ppm/year	Room Temperature, Typical

Power Derating

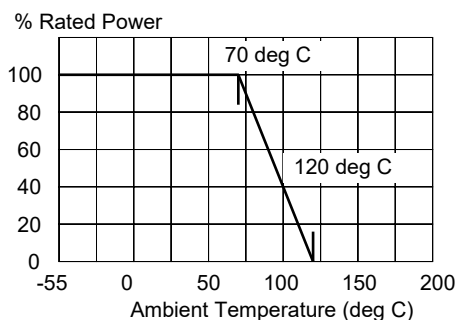

Note

1. Since a special resistor structure is used in the resistance of 10 ohms or less, the label marking method may differ from the case of other resistance.
2. The performance of an short time overload test is the specification about one time overload test. Please do not apply the continuous pulse exceeding rated power.
3. When you apply continuous pulse, please care not to exceed the range of a derating curve and not to exceed maximum working voltage and maximum working current.

1/4W, 1/2W, 1W, 2W Precision Chip
R1206, R1210, R2010, R2512, R3020

Frequency Characteristics

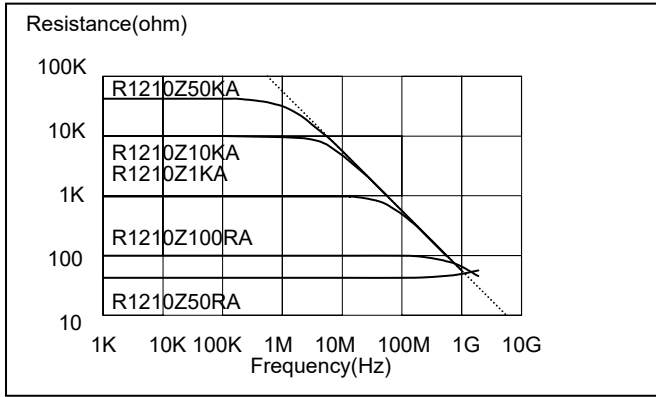

Temperature Characteristics

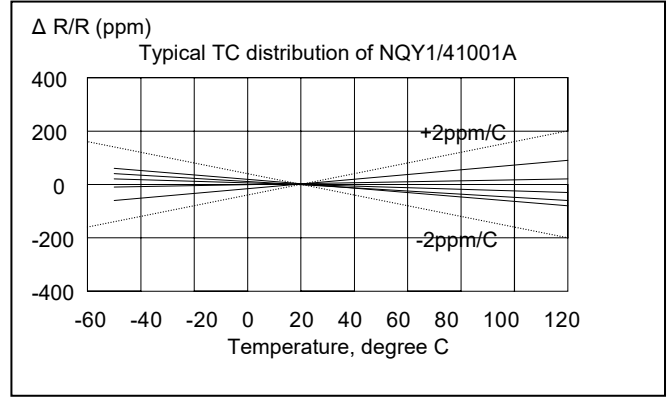

Packaging (please call factory)

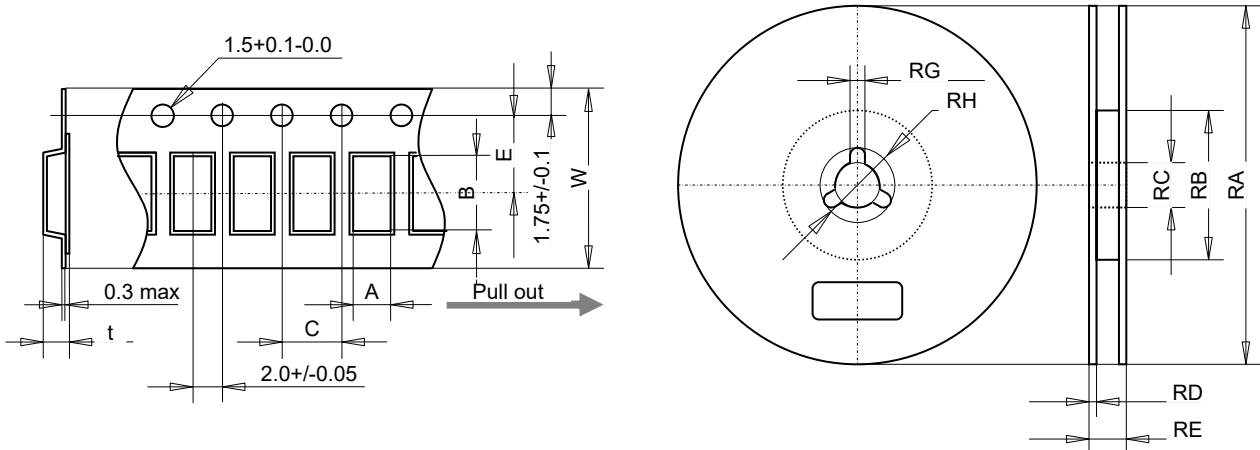

Tap Dimensions

	A	B	C	W	E	t	Note
R1206	2.00±0.15	3.60±0.15	4.0±0.1	8.0±0.2	3.50±0.05	1.0 max.	
R1210	2.85±0.15	3.50±0.15		8.0±0.2	3.50±0.05	1.0±0.20	
R2010	3.10±0.15	5.50±0.15		12.30±0.2	5.50±0.05	1.1±0.15	
R2512	3.60±0.15	6.90±0.15		12.30±0.2	5.50±0.05	1.1±0.15	
R3020							

Reel Dimensions

	RA	RB	RC	RD	RE	RG	RH
R1206	φ 180±0/-1.5	φ 60±1/-0	φ 13±0/-0.2	9.0±1.0/-0.0	11.4±/-1.0	2.0±/-0.5	21±/-0.8
R1210							
R2010					13.0±/-1.0		
R2512							
R3020							

Quantity per Reel

	Quantity
R1206	1000pcs, 2000cs
R1210	1000pcs, 2000pcs
R2010	1000pcs, 2000pcs
R2512	1000pcs
R3020	1000pcs

20211101