

TO263 SURFACE MOUNT  
50W HIGH POWER RESISTORS  
RNP-50F

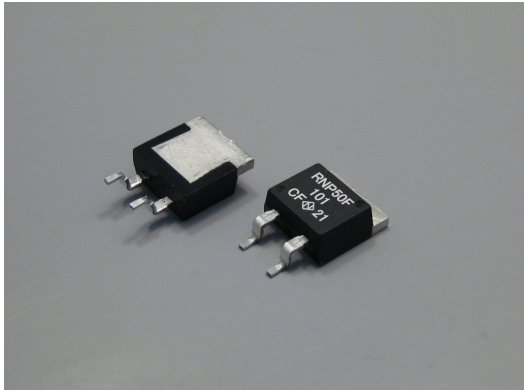

Features and Applications

50W high power resistors, high soldering temperature in TO263 (D2-PAK) style surface mount mold package with matte Tin plated flange.  
 Non-inductive design suits high frequency applications and high-speed pulse circuits.  
 Low, 2.3 °C/W heat resistance from resistor hot spot to flange and long life performance are presented with thin film metallization technology.  
 Wide, 20 mΩ to 51K Ω resistance range, non-inductive impedance characteristic and heat extracting through insulated metal flange aids circuit designers.  
 Applications for UPS, power unit of machines, motor control, drive circuits, automotive, measurements, industrial computers and high frequency electronics.

Dimensional Specifications (mm)

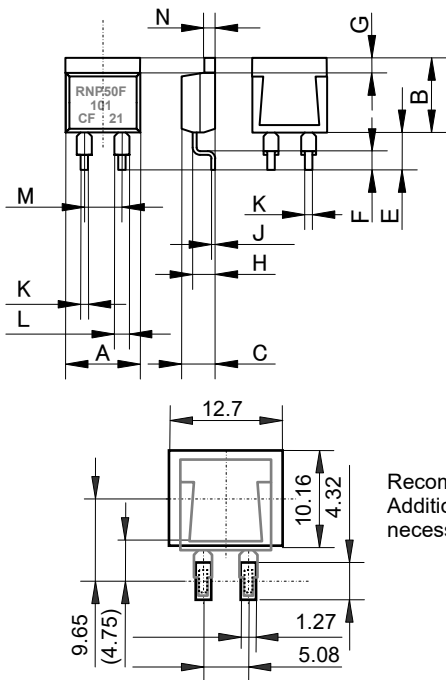

RNP-50F		
	mm	+/-mm
A	10.1	+/-0.2
B	10.3	+/-0.2
C	4.5	+/-0.2
D	-	-
E	5.0	+/-1.0
F	2.5	+/-0.5
G	2.2	+/-0.2
H	2.75	+/-0.2
J	0.5	+/-0.05
K	0.75	+/-0.05
L	1.5	+/-0.05
M	5.08	+/-0.10
N	1.5	+/-0.05

Recommended Land Pattern. (mm)  
 Additional heat cooling system will be necessary

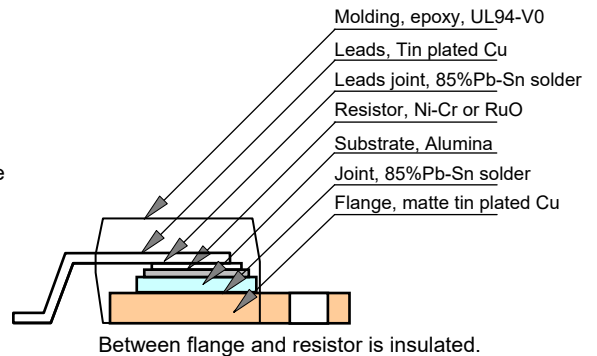
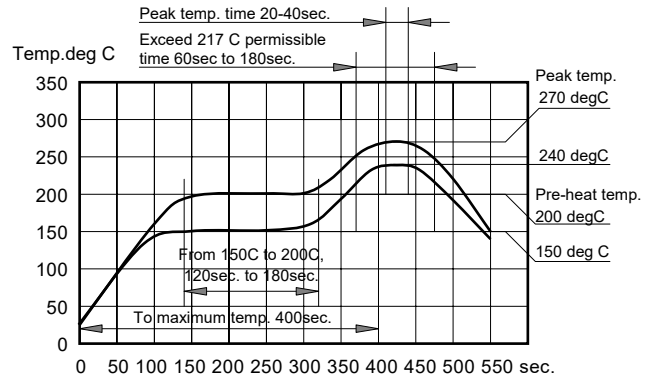

形名称 Ordering Information

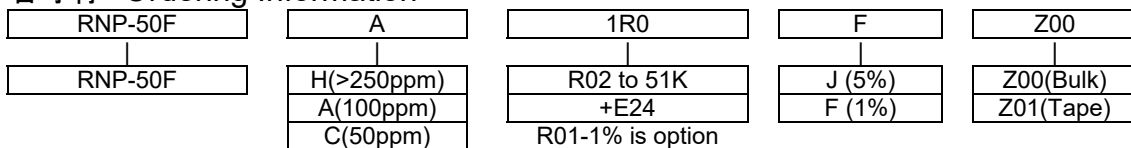

Z: RoHS

Resistance value (\*) is available following modified E24, +E24.

1.0	1.1	1.2	1.3	1.5	1.6	1.8	2.0	2.2	2.4	2.5	2.7	3.0	3.3
3.6	3.9	4.0	4.3	4.7	5.0	5.1	5.6	6.2	6.8	7.5	8.0	8.2	9.1

TO263 SMD 50W HIGH POWER RESISTORS

RNP-50F

Specifications

	RNP-50F			Test Conditions
Rating Power	50 Watt			-55 deg C to 25 deg C flange temperature
Rating Power	2 Watt			Attached on simple foot print.
Heat Resistance	2.3 deg C/W			Resistor hot spot to flange
Resistance Range	0.02-0.091Ω	0.1-9.1Ω	10-51KΩ	Note 2
Nominal	E6	E24	E24	Include 2.5, 4.0, 5.0, 8.0 and 16
TCR (ppm/deg C)	250(H)	100 (A)	50 (C)	Note 3.
Tolerance	5%(J)	1% (F) 5% (J)	+/-1% (F)	1% tolerance at 0.01-0.091 Ω are available.
Resistor materials	Thick film	Thick film	Thin film	100 ppm/°C thick film are available in 10Ω-51kΩ
Capacitance	1.44pF			Equivalent parallel capacitance.
Inductance	8.38nH			Equivalent series inductance
Operation Temp.	-55 deg C to +155 deg C			
Operating Volt.	Either 500V or $\sqrt{P \cdot R}$			P is rating power and R resistance
Withstanding Volt.	2000 VAC			Terminal and flange, 60 seconds. 1mA
Load Life	+/- 1.0 %			25 deg C, 90 min.ON, 30 min. OFF, 1000h.
Humidity	+/- 1.0 %			40 deg C, 90-95%RH, DC 0.1W, 1000 hours.
Temp. Cycle	+/- 0.25 %			-55 deg C,30 min.,+155 deg C,30 min., 5cyc
Soldering Heat	+/- 0.1 %			350+/-5 deg C, 3seconds.
Lead Solder ability	Over 95% of surface			245+/-5 deg C, 3seconds.
Insulation Resistance	Over 1,000 Meg Ω			Between terminals and tab.
Vibration	+/- 0.25 %			IEC60068-2-6, see note 4
Flammability	UL94-V0			
Weight	1.5 grams			

Power Derating

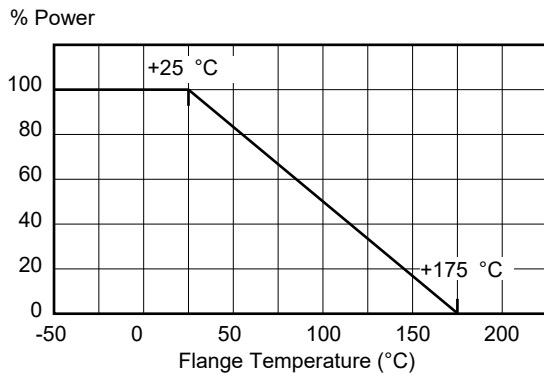

Pulse Energy Durability

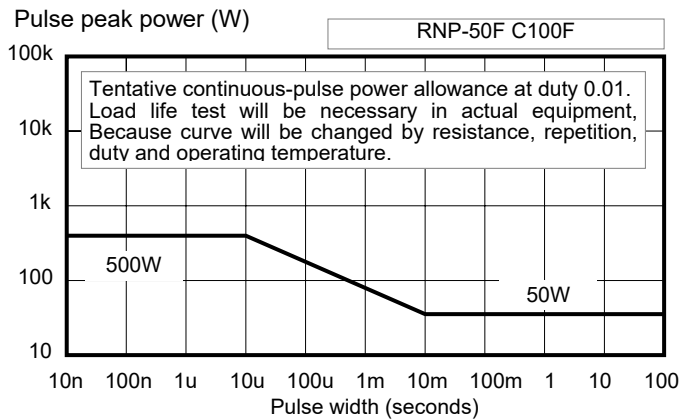

Tape Dimension

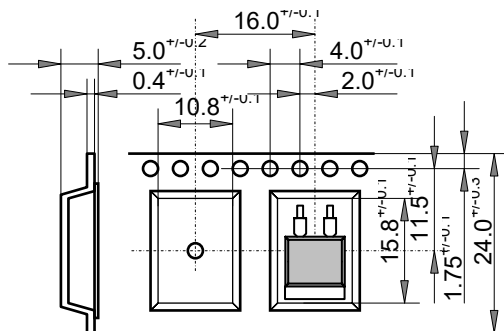

Reel Dimension

Outer diameter: 330 mm  
 Inner diameter: 100 mm  
 Width: 23.9 mm min. 27.4 mm max  
 Package quantity: 500pcs/13 inches reel

Note:

- (1) Flange insulation is not necessary between flange and heat-sink, flange and resistor is separated by alumina substrate.
- (2) Resistance measurement shall be made at terminal foot portion.
- (3) TCR of low resistance will be increased as 300ppm/0.02Ω, 200ppm/0.05Ω, 140ppm/0.1Ω and 80ppm/0.2Ω typically. Testing point is at 5.27mm from bottom of molding of terminals.
- (4) Test method is IEC60068-2-6, and specification is sine sweep wave form, 100Hz-2000Hz, 10 cycles, amplitude 0.75mm or 100m/s<sup>2</sup>, 90minutes. direction x-y z, Amplitude 0.75mm will be applied under break point frequency (about 60Hz) and 100m/s<sup>2</sup> over break point
- (5) Standard packaging is tape reel, a tape reel contains 500pcs. when small quantity, tube packaging will be used, the tube is made by RoHS PS/PE which contains 50pcs / tube.